

SHORT-PERIODIC OSCILLATIONS OF THE MAGNETIC FIELD OF THE SUN AS A STAR

B. A. IOSHPA, V. N. OBRIDKO, and B. D. SHELTING

*The Institute of Terrestrial Magnetism, Ionosphere and Radiowave Propagation,
Academy of Sciences of the U.S.S.R., Moscow, U.S.S.R.*

(Received 5 July, in revised form 24 October, 1972)

Abstract. Correlation analysis applied to recordings of the magnetic field and velocity of the Sun as a star reveals oscillations close to 300 s. The power spectrum of these oscillations is discussed.

Numerous recent investigations have shown the presence of short-periodic oscillations of the brightness, velocity and magnetic field in separate parts of the solar surface (see, for instance, Tanenbaum *et al.*, 1971). These oscillations with period ≈ 300 s have dimensions of about $10''$ – $20''$; the coherence between the oscillations rapidly vanishes with distance. On the other hand, radio-astronomical observations have shown the presence of short-periodic oscillations in regions of about some arc-minutes (Yudin, 1968). It seems interesting to investigate the behaviour of the Sun as a star, to clear up the question about the global short periodic oscillations of the whole Sun.

To investigate this problem a parallel beam from the coelostat has been directed on the entrance slit of the spectrograph of the IZMIRAN tower telescope. The optical set-up is shown in Figure 1. After reflection from the coelostat mirror 1 and the secondary mirror 2 the beam is directed towards the spectrograph slit 4 by the diagonal mirror 3. The solar image formed in accordance with the camera obscura principle has a diameter of ≈ 22 cm near the diagonal mirror plane. This solar image, however, is smoothed by the instrumental profile of the camera obscura; the diameter of this profile coinciding with the diameter of the telescope's entrance aperture. Both mirrors of our coelostat system have the same diameter, viz. 440 mm. Taking into account the angle between the mirror axes and the vertical line, the effective diameter of the entrance window ≈ 30 – 35 cm. Therefore, in the center of the sun-beam going from the secondary mirror a smooth region exists, with diameter 30–35 cm, where the light from all parts of the Sun is well mixed. From that region the diagonal mirror (diameter 180 mm) receives the light and directs it to the spectrographic entrance slit. Inside the spectrograph a solar image originates with a diameter in the collimator plane ≈ 9 cm. The dimensions of the spectrograph mirrors 5, 7 and the grating 6 exceed this image, and therefore all the light from a certain spectral line comes to the exit slit. So all the elements of the solar surface contribute to the illumination of the spectrograph slit.

The brightness, the longitudinal component of the magnetic field and the radial velocity in Fe I 5250 Å were measured with the magnetograph of IZMIRAN. The

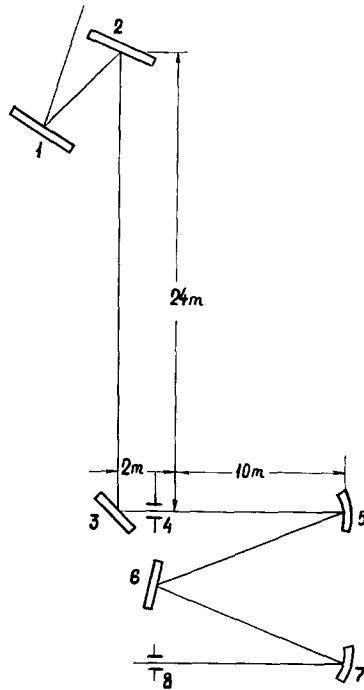

Fig. 1. The optical scheme of the telescope and the spectrograph when the Sun was observed as a star: (1) coelostat mirror; (2) secondary mirror; (3) diagonal mirror; (4) entrance spectrograph slit; (5, 6, 7) collimator mirror, grating and camera mirror respectively; (8) the exit spectrograph slit.

sensitivity of the magnetic field measurements was $\approx 0.2\text{G}$, and of the velocity measurements $\approx 200\text{--}200\text{ m s}^{-1}$. The brightness in the line's wings was recorded with an accuracy up to 3%. We analyze here three observations: two of them were produced on May 20th, 1971, and one on May 30th, 1971. The brightness recordings showed no visible oscillations. Therefore, we only discuss the recordings of magnetic field and velocity. The autocorrelation functions and power spectra were calculated by means of correlation analysis (Blackman and Tukey, 1958). The procedure is described below. First the autocorrelation function $B_u(l)$ was derived

$$B_u(l) = \frac{1/(N-l+1) \sum_{t=0}^{N-l} (u_t - \bar{u})(u_{t+l} - \bar{u})}{1/(N+1) \sum_{t=0}^N (u_t - \bar{u})^2},$$

where $u(t)$ is the measured parameter taken at uniformly spaced values, viz. $t=0, \Delta t, 2\Delta t, \dots, N\Delta t$. N is the total number of points in the sample, l is the correlation variable 'lag', the maximum value of l was taken $(N+1)/4 = m$, \bar{u} is the mean value of u .

TABLE I
Time of the observations and parameters of the calculation procedure

<i>n</i>	Time UT	Full interval	Total num- ber of points	The interval between the points Δt	The parameters measured
I	20.5.1971 11 ^h 30 ^m – 12 ^h 09 ^m	39 min	620	3.75 s	H, V, I in the line Fe I λ 5250
II	20.5.1971 13 ^h 30 ^m – 14 ^h 46 ^m	74 min 37 ^a 28 ^b	600 600 450	7.5 s 3.75 3.75	H, V, I in the line Fe I λ 5250
III	30.5.1971 7 ^h 50 ^m – 8 ^h 42 ^m	52 min	420	7.5 s	H, V, I, in the line Fe I λ 5250

^a Samples twice shorter than the full samples.

^b Shortened half-period sample.

In our case $u(t)$ may be either the magnetic field intensity or the radial velocity. Then the spectral power

$$S_{B_u} = \delta_k \frac{1}{m} \sum_{l=0}^{m-1} B_u \left(1 + \cos \frac{\pi l}{m} \right) \cos \frac{k\pi l}{m}, \quad k = 0, 1, 2, \dots, m$$

$$\delta_k = \begin{cases} \frac{1}{2} & k = 0, k = m \\ 1 & k \neq 0, u \neq m \end{cases}$$

and the spectrum of the quantity itself

$$S_u = \delta_k \frac{1}{N+1} \sum_{t=0}^N u_t \left(1 + \frac{\pi t}{N+1} \cos \frac{k\pi t}{N+1} \right), \quad k = 0, 1, 2, \dots, N$$

were derived.

The relevant data of the observations and the parameters of the calculation procedure are given in Table I.

Special attention was paid to the recordings of the magnetic field. Figure 2 represents the autocorrelation function and the power spectrum for the first observational period on May 20. The power spectrum for the magnetic field has a wide maximum in the interval 580–200 s with peak at 390 s. The maxima of the power spectrum for the radial velocities correspond to 50 and 80 s. The curves for the second period of observation, May 20th, are presented in Figure 3. The maximum of the power spectra for the magnetic field is at 370–320 s. The maximum of the power spectrum

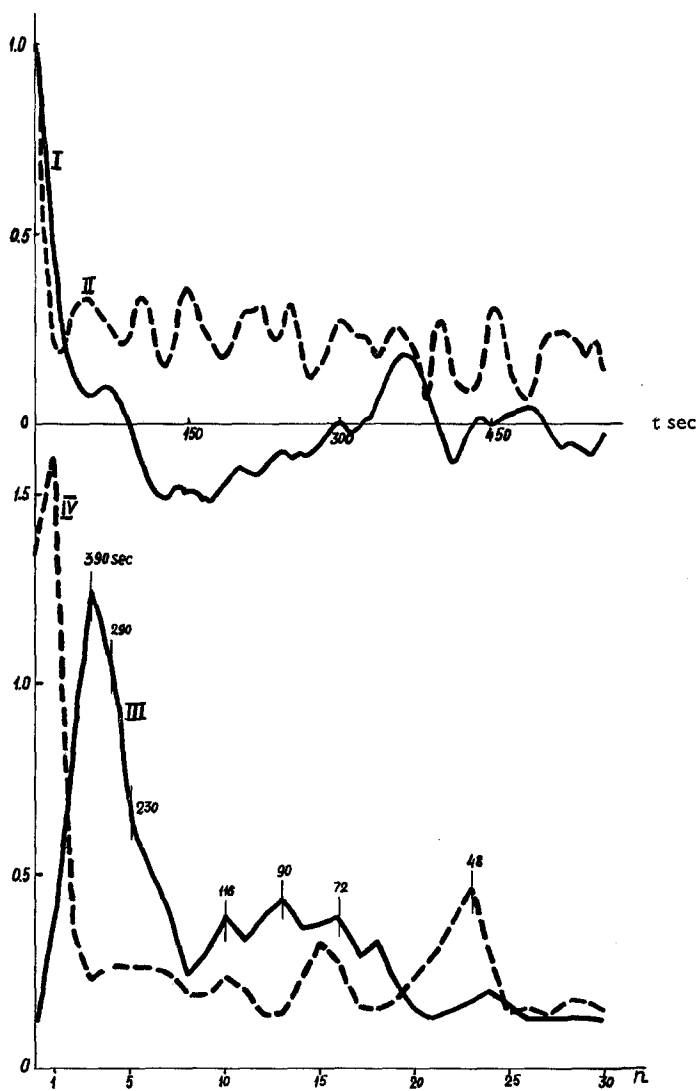

Fig. 2. *Above*: correlation functions for the magnetic field (I) and for the radial velocity (II); *below*: the power spectra in arbitrary units for the magnetic field (III) and for the velocity (IV). The recording was obtained during the first observational period of 39 min duration on May 20th, 1971; n is the wave number.

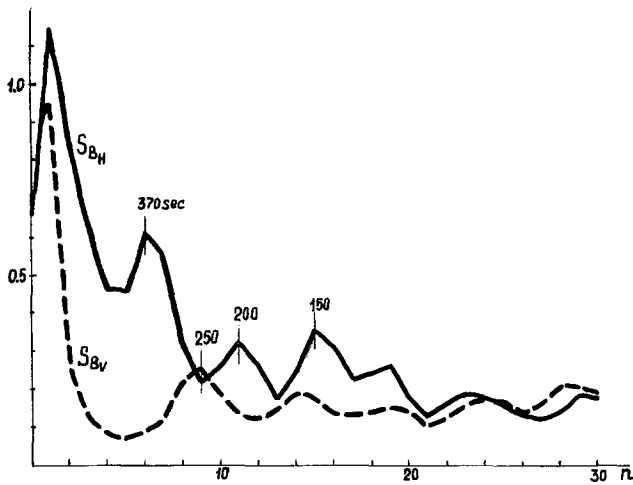

Fig. 3. The power spectra in arbitrary units of the magnetic field S_{BH} and the radial velocity S_{BV} for the second observational period, of 74 min duration, on May 20th, 1971.

for the radial velocity corresponds to 250 s. The recording of the magnetic field made during the second observational period on 20 May was analyzed in some more detail. We took an interval of 37 min equal to half the second total observational period and shifted its beginning from the start to the middle of the total period through every 20 min successively. So we received 3 shortened samples; the first of them coincided approximately with the first half of the total period, the last with the second half, and the second was in the middle of the total sample. The power spectra for these samples are given in Figure 4. The oscillations are seen best for the first sample. The maximum of the power spectrum is within the interval 370–280 s; harmonics are well expressed, especially the second ≈ 140 s and the fourth ≈ 70 s (relative to 280 s-oscillation). The Fourier spectrum of this sample itself is presented in Figure 5. The spectrum consists of separate frequencies settled down within the maximum of the power spectrum; the strongest of them are 340 and 260 s. The character of the power spectra varies with time. The maximum at 400–300 s for the samples shifted more than 20 min diminishes, but appear the maxima on the higher frequencies. The magnitude of the oscillations becomes smaller. One can see from Figure 5 that the magnitude of the oscillations with periods of ≈ 300 s is equal to 60% of the constant component magnitude. The mean value of the field for different samples is about several gauss. To emphasize the oscillations in the first sample it was shortened from the end of $\frac{1}{4}$ of its full duration. Figure 6 shows the corresponding autocorrelation function and the power spectrum. The oscillations are more strongly expressed, and the maximum of the power spectrum of the magnetic field corresponds to the 280s period. The discussion of the magnetic field recording obtained on May 30th revealed no reliable oscillations (Figure 7).

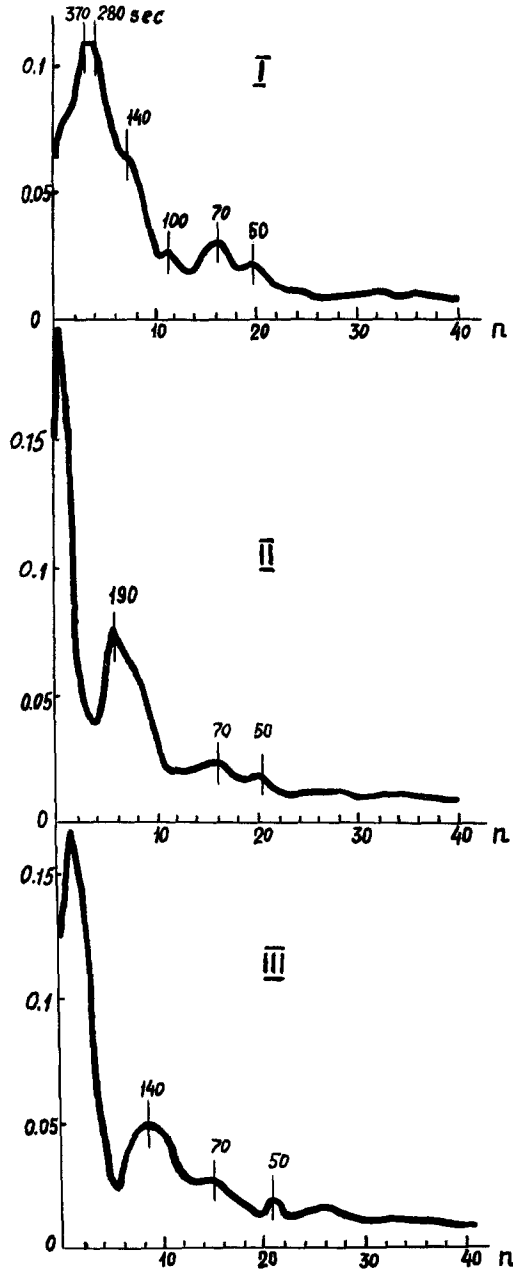

Fig. 4. The power spectra (in arbitrary units) of the magnetic field for the recordings shifted relative to each other by 20 min for the second observations on May 20th, 1971. The spectrum (I) corresponds approximately to the first half of the total recording; the spectrum (III) to its second half.

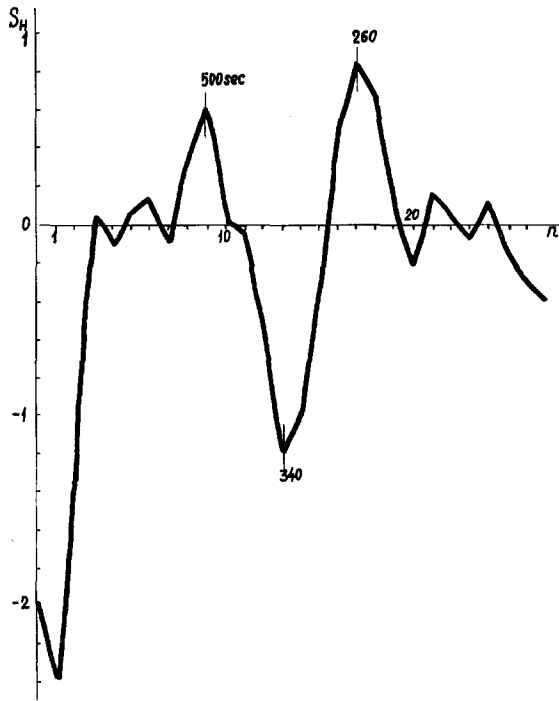

Fig. 5. The spectrum of the measured quantity itself for the first half of the second observational period on May 20th for the magnetic field. The corresponding power spectrum is shown on Figure 4 (I).

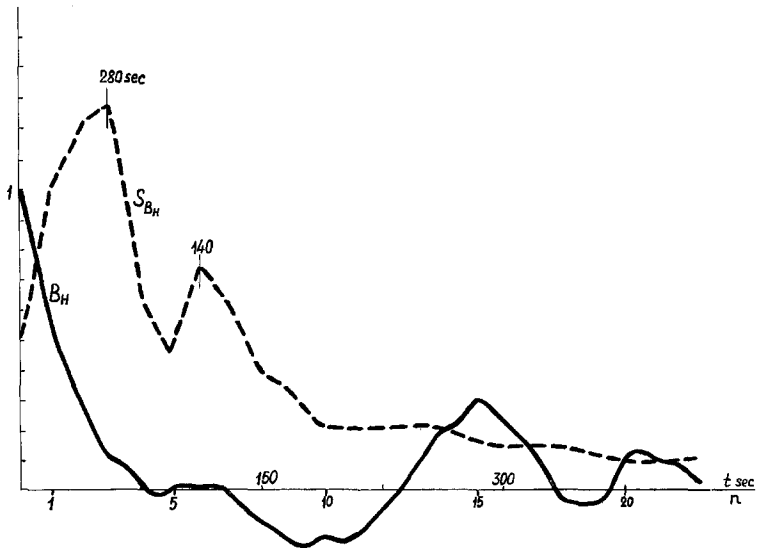

Fig. 6. The autocorrelation function B_H and the power spectrum S_{B_M} for the magnetic field of the shortened sample (I) (Figure 4). The full duration of this sample was 28 min.

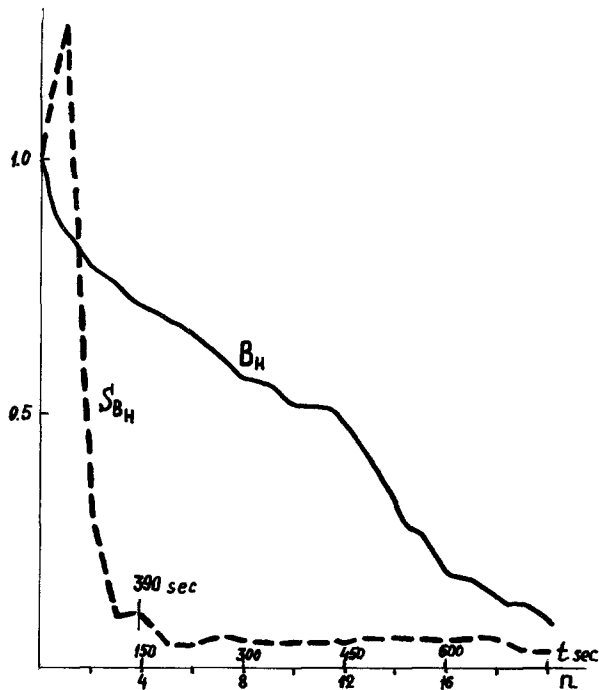

Fig. 7. The autocorrelation function B_H and the power spectrum S_{B_H} for the magnetic field for the observations on May 30th, 1971; the duration of the observations was ≈ 52 m.

Conclusions

(1) The statistical analysis of the magnetic field of the Sun as a star reveals oscillations with a period ≈ 300 – 400 s.

(2) The magnitude and frequency of these oscillations change with time. In some periods these oscillations are practically absent.

(3) the oscillations of the radial velocity were also recorded; their periods appear to be less than the oscillation period for the magnetic field.

It should be emphasized that these results are preliminary; more detailed investigations are necessary to examine the reality of the effect and to specify its characteristics. The analysis should take into account the possible non-stationary character of the process.

Acknowledgements

The authors are grateful to Dr E. I. Mogilevsky for his attention to this work.

References

- Blackman, R. B. and Tukey, J. W.: 1959, *The Measurements of Power Spectra*, Dover Publications, New York.
- Tanenbaum, A. S.: 1971, Ph. D. Thesis. *Space Sci. Lab. Ser.* **12** (38), 1–140.
- Yudin, O. I.: 1968, *Dokl. Akad. Nauk SSSR. Astron.* **180**, 821.